

# KLINKERRIEMCHEN THIN BRICK

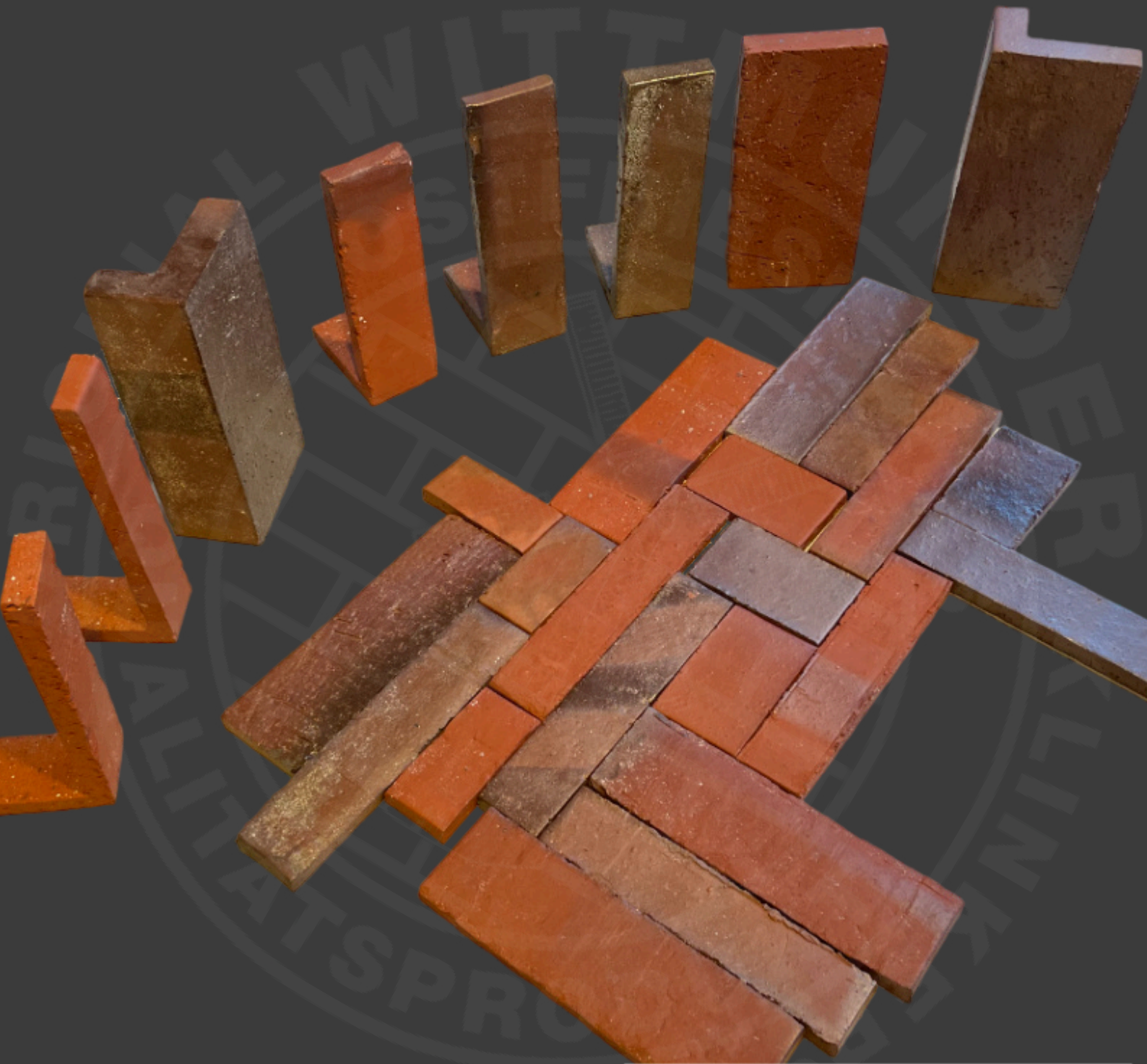

***Wittmunder  
Klinker***

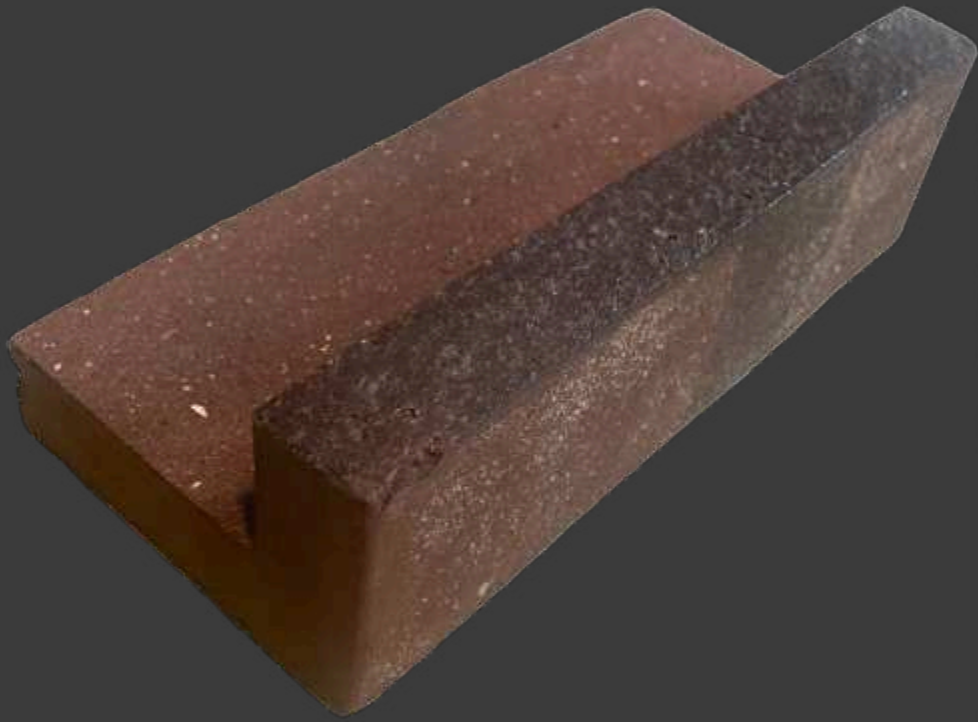



| Format | Abmessungen<br>Size | Bedarf je m <sup>2</sup><br>Pieces per sqm | Winkelriemchen je lfd. m<br>Edge Corners per m |
|--------|---------------------|--|--|
| OF     | 220x15x52 mm        | 72   | 16   |
| DF     | 240x15x52 mm        | 64   | 16   |
| HF     | 220x15x65 mm        | 56   | 13   |
| NF     | 240x15x71 mm        | 48   | 12   |

Unsere Klinkerriemchen können ab einer Stärke von 15 mm bis zu 45mm hergestellt werden.  
Weitere Stärken / Formate und Sonderteile auf Anfrage

Thin Bricks can be produced in thickness from 15 to 45mm. Other thicknesses sizes and special parts on request

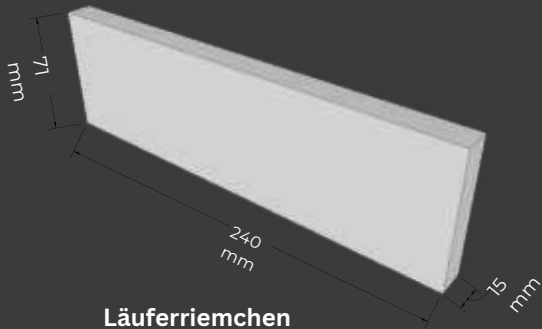

**Läuferriemchen**  
Thin Brick

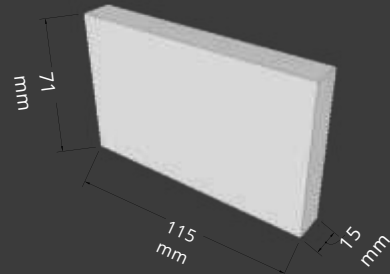

**Kopfriemchen**  
Header

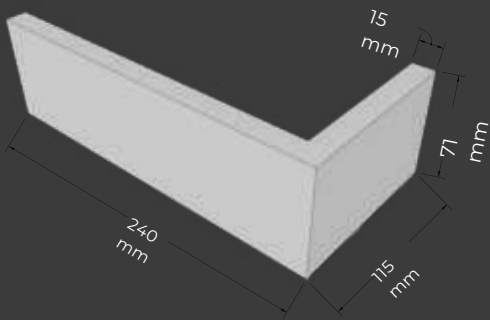

**Winkelriemchen**  
Thin Brick Corner

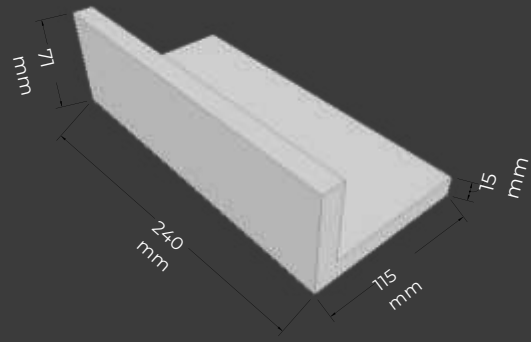

**Läufervollsteinwinkel**  
Edge Corner

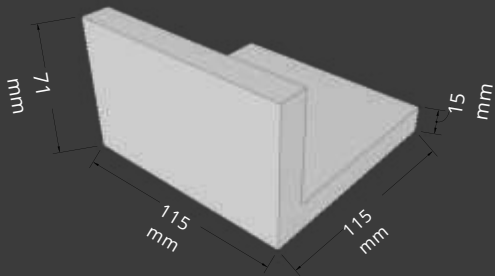

**Kopfvollsteinwinkel 1**  
Header Edge Corner 1

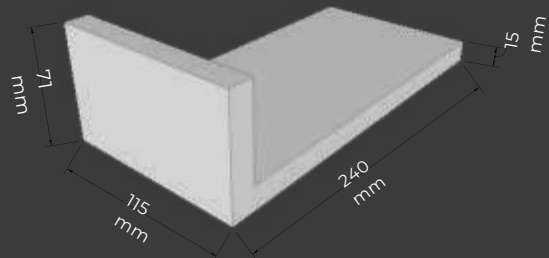

**Kopfvollsteinwinkel 2**  
Header Edge Corner 2

Die abgebildeten Riemen und Sonderteile können in vielen verschiedenen Formaten hergestellt werden.

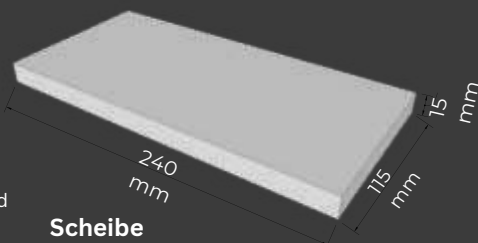

**Scheibe**  
Slice

The illustrated thin bricks and special parts can be produced in many different formats.



JEAN PAUL WEG - HAMBURG  
A2b | Architekt boris bollmann  
RIEMCHEN IN VERSCHIEDEN FORMATEN & SORTIERUNGEN  
THIN BRICKS IN DIFFERENT SIZES AND COLORS





Sortierung 27



Sortierung 191D





MOTEL ONE FLEETINSEL - HAMBURG  
NALBACH+NALBACH ARCHITEKTEN,  
BERLIN  
RIEMCHEN SORTIERUNG 187 DÜNNFORMAT  
THIN BRICKS - TYPE NO 187





Sortierung 72



Sortierung 198





Wohnbebauung CH-Bülach  
BAUKONTOR ARCHITEKTEN, ZÜRICH  
RIEMCHEN SORTIERUNG NR. 26  
THIN BRICK TYPE NO. 26



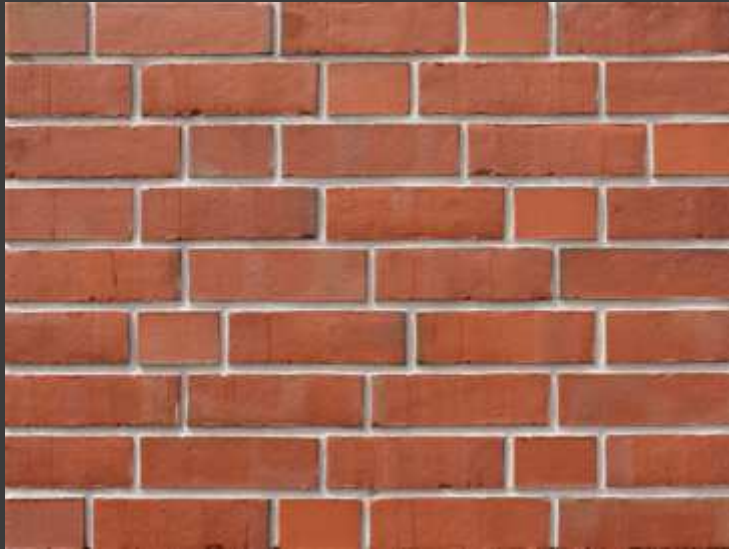

Sortierung 18

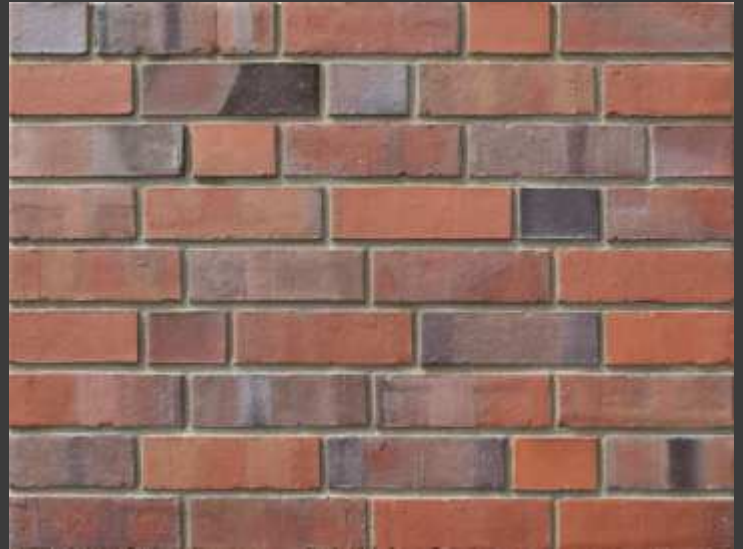

Sortierung 151

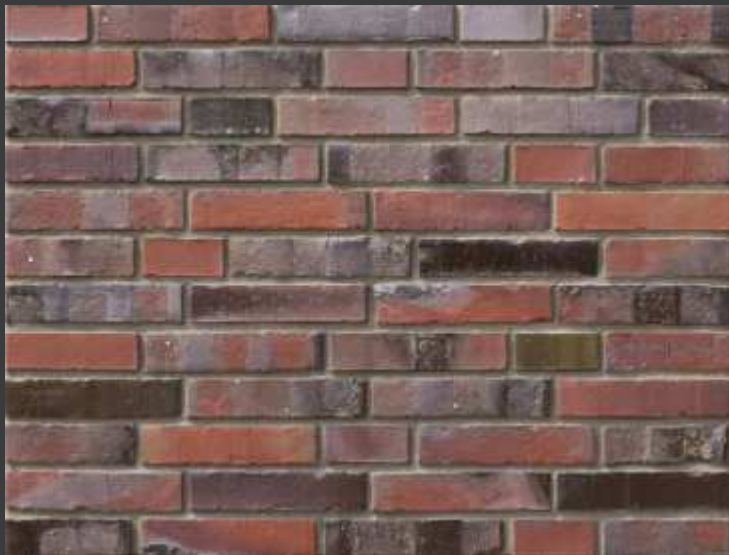

Sortierung 219

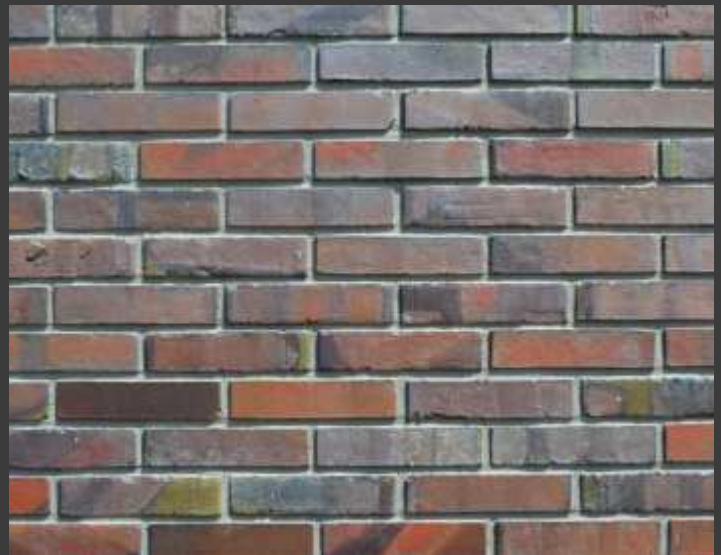

Sortierung 207

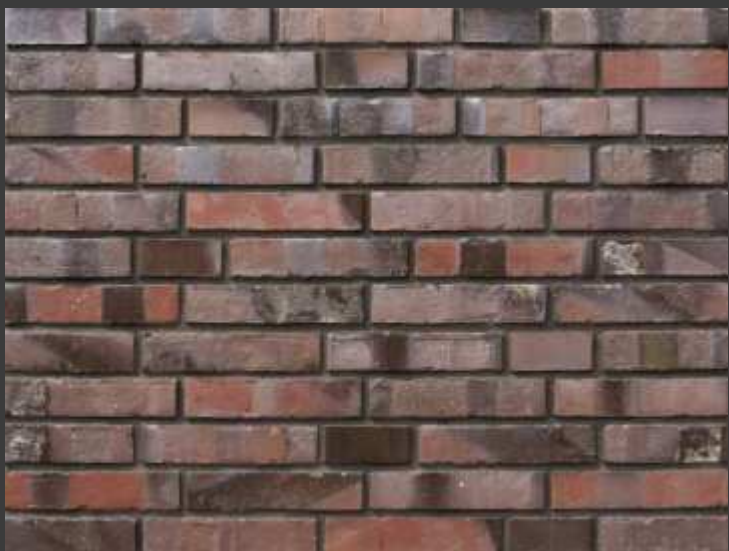

Sortierung 26

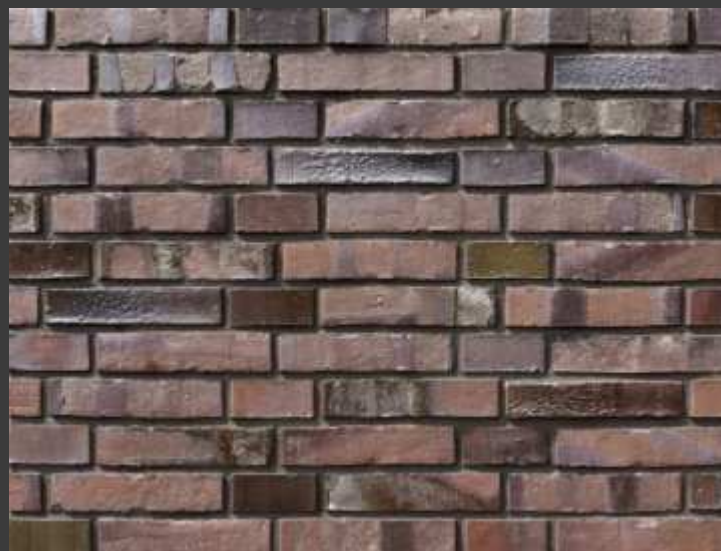

Sortierung 2



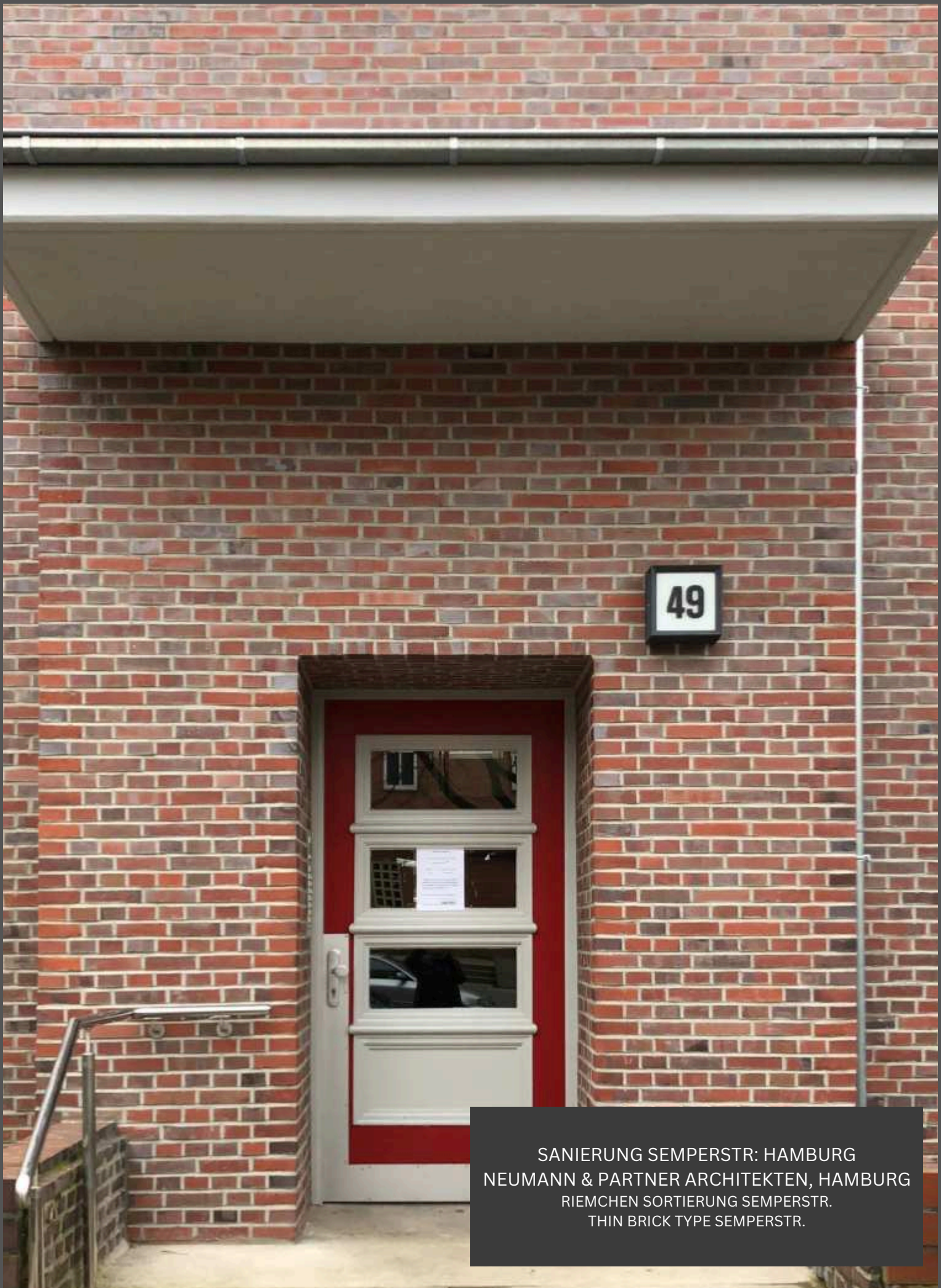

SANIERUNG SEMPERSTR: HAMBURG  
NEUMANN & PARTNER ARCHITEKTEN, HAMBURG  
RIEMCHEN SORTIERUNG SEMPERSTR.  
THIN BRICK TYPE SEMPERSTR.



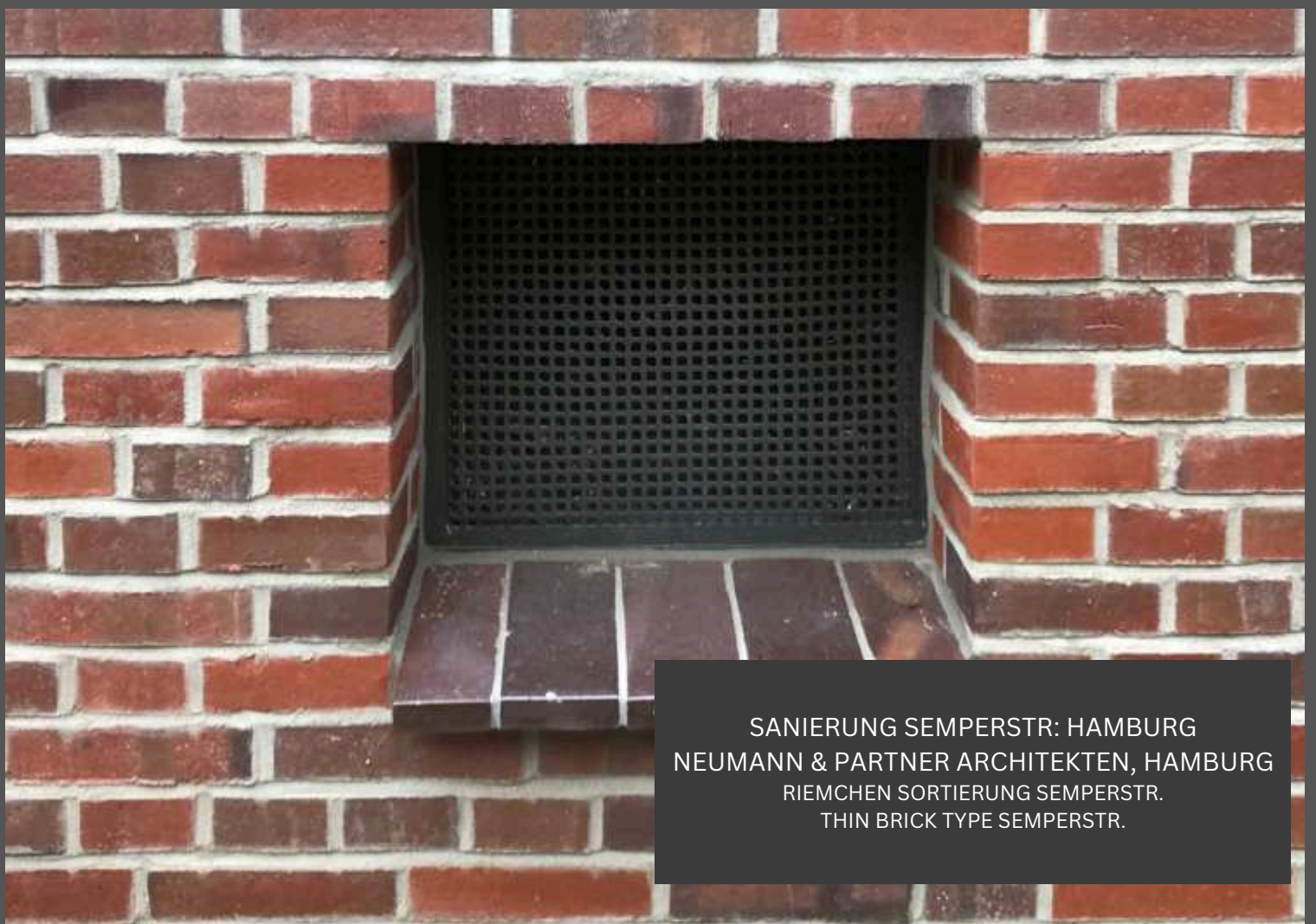

SANIERUNG SEMPERSTR: HAMBURG  
NEUMANN & PARTNER ARCHITEKTEN, HAMBURG  
RIEMCHEN SORTIERUNG SEMPERSTR.  
THIN BRICK TYPE SEMPERSTR.



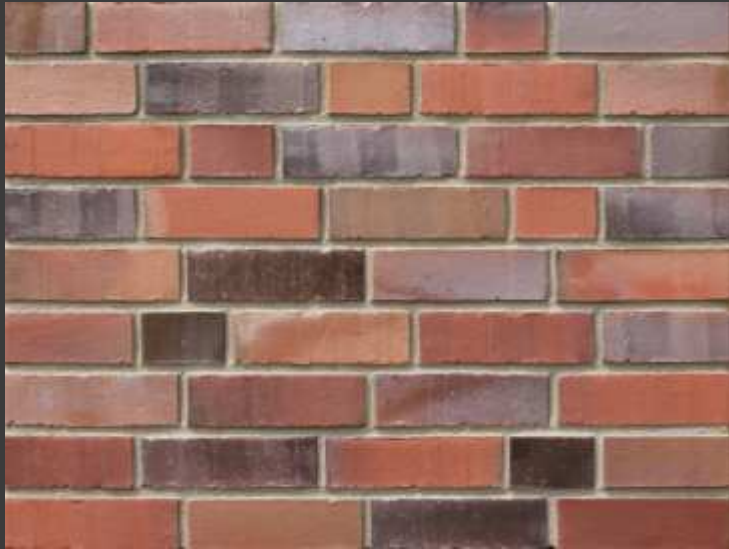

Sortierung 6

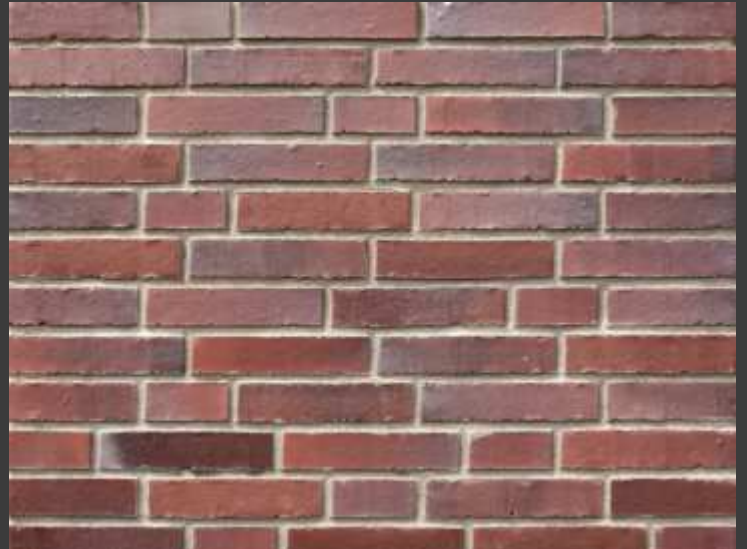

Sortierung 9

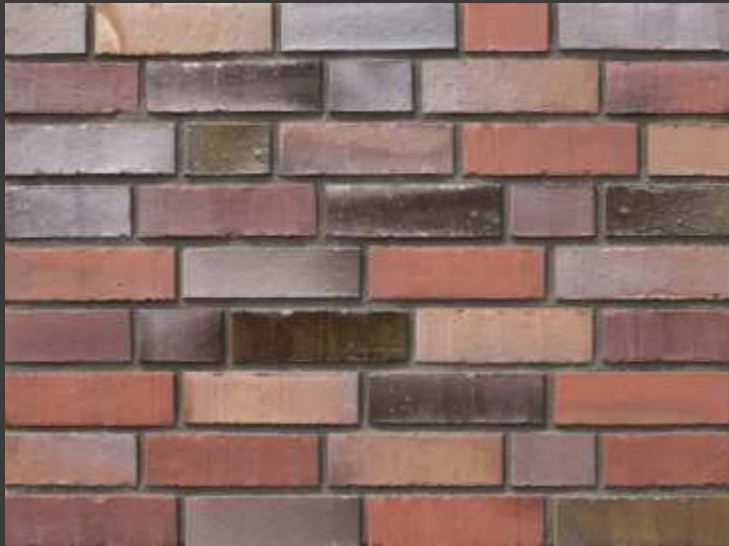

Sortierung 16

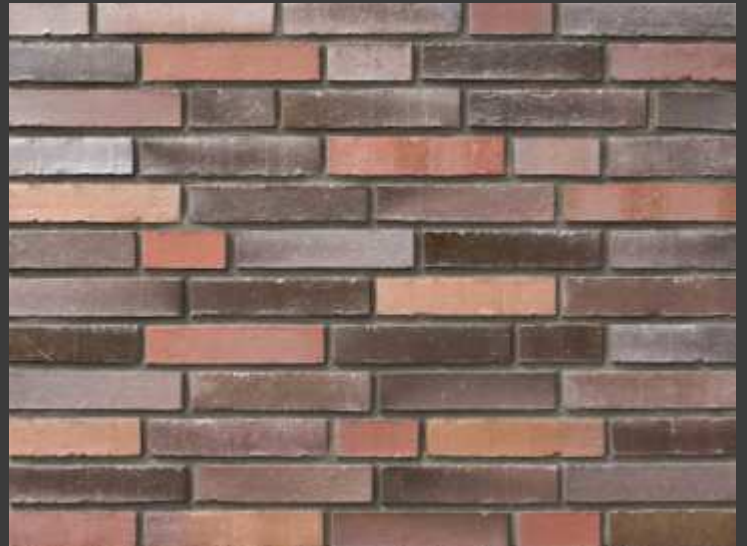

Sortierung 132



Sortierung 11



Sortierung 139













MFH K - HAMBURG  
RIEMCHEN SORTIERUNG 26.1 NORMALFORMAT  
THIN BRICKS - TYPE NO 26.1





Wittmunder Klinker | Werk Neuschoo  
Ziegeleiweg 1  
DE - 26487 Neuschoo  
+49 4462 9474-0  
[info@wittmunder-klinker.de](mailto:info@wittmunder-klinker.de)  
[www.wittmunder-klinker.de](http://www.wittmunder-klinker.de)